

GUTTERCREST

ALUMINIUM

RAKED BOX GUTTERS



PRICE LIST

PRICE LIST

RAKED BOX GUTTER SYSTEM

STANDARD GUTTER LENGTHS

Gutter (mm)	100 x 75	100 x 100	125 x 100	150 x 100	150 x 150	200 x 150	200 x 200	300 x 200
3.0mtr	RBX1/1	RBX2/1	RBX3/1	RBX4/1	RBX5/1	RBX6/1	RBX7/1	RBX8/1
MILL	76.65	86.06	89.37	91.13	108.39	131.56	142.80	186.11
PPC	85.37	96.41	100.66	103.23	123.75	148.61	163.10	210.09
1.5mtr	RBX1/2	RBX2/2	RBX3/2	RBX4/2	RBX5/2	RBX6/2	RBX7/2	RBX8/2
MILL	49.30	53.69	59.47	59.68	69.62	83.62	95.06	120.43
PPC	53.66	58.87	65.12	65.74	77.30	92.15	105.22	132.43

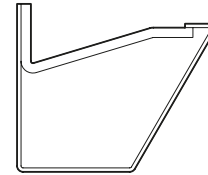
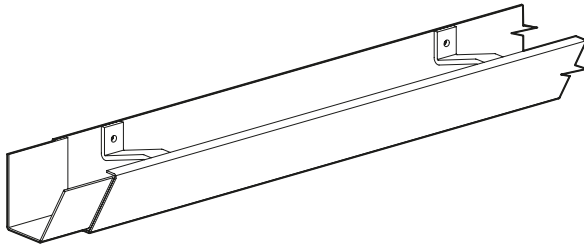

STOP ENDS

Gutter (mm)	100 x 75	100 x 100	125 x 100	150 x 100	150 x 150	200 x 150	200 x 200	300 x 200
Stop End Right Hand	RBX1/10	RBX2/10	RBX3/10	RBX4/10	RBX5/10	RBX6/10	RBX7/10	RBX8/10
MILL	8.14	8.30	8.44	8.51	9.87	11.80	12.40	14.35
PPC	8.69	8.85	8.99	9.06	10.42	12.35	13.01	15.19
Stop End Left Hand	RBX1/11	RBX2/11	RBX3/11	RBX4/11	RBX5/11	RBX6/11	RBX7/11	RBX8/11
MILL	8.14	8.30	8.44	8.51	9.87	11.80	12.40	14.35
PPC	8.69	8.85	8.99	9.06	10.42	12.35	13.01	15.19

NOTE: THESE ARE INTERNAL STOP ENDS

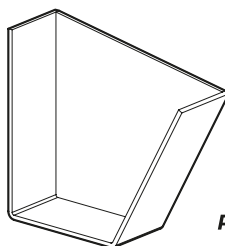

Right Hand shown

PRICE LIST

RAKED BOX GUTTER SYSTEM

ANGLES INTERNAL & EXTERNAL

Gutter (mm)	100 x 75	100 x 100	125 x 100	150 x 100	150 x 150	200 x 150	200 x 200	300 x 200
90° External	RBX1/3	RBX2/3	RBX3/3	RBX4/3	RBX5/3	RBX6/3	RBX7/3	RBX8/3
MILL	47.26	51.92	54.79	58.42	68.31	82.45	94.14	114.36
PPC	48.83	53.77	57.03	60.93	71.49	86.27	98.68	120.13
90° Internal	RBX1/4	RBX2/4	RBX3/4	RBX4/4	RBX5/4	RBX6/4	RBX7/4	RBX8/4
MILL	47.26	51.92	54.79	58.42	68.31	82.45	94.14	114.36
PPC	48.83	53.77	57.03	60.93	71.49	86.27	98.68	120.13
135° External	RBX1/5	RBX2/5	RBX3/5	RBX4/5	RBX5/5	RBX6/5	RBX7/5	RBX8/5
MILL	46.13	50.39	54.63	56.35	65.57	82.01	90.47	109.97
PPC	47.52	52.03	56.63	58.58	68.39	85.15	94.20	114.78
135° Internal	RBX1/6	RBX2/6	RBX3/6	RBX4/6	RBX5/6	RBX6/6	RBX7/6	RBX8/6
MILL	46.13	50.39	54.63	56.35	65.57	82.01	90.47	109.97
PPC	47.52	52.03	56.63	58.58	68.39	85.15	94.20	114.78
Irregular External	RBX1/7	RBX2/7	RBX3/7	RBX4/7	RBX5/7	RBX6/7	RBX7/7	RBX8/7
MILL	78.06	82.67	85.99	90.97	102.66	123.80	128.26	149.55
PPC	80.17	85.16	88.82	94.20	106.76	128.36	133.68	156.24
Irregular Internal	RBX1/8	RBX2/8	RBX3/8	RBX4/8	RBX5/8	RBX6/8	RBX7/8	RBX8/8
MILL	78.06	82.67	85.99	90.97	102.66	123.80	128.26	149.55
PPC	80.17	85.16	88.82	94.20	106.76	128.36	133.68	156.24

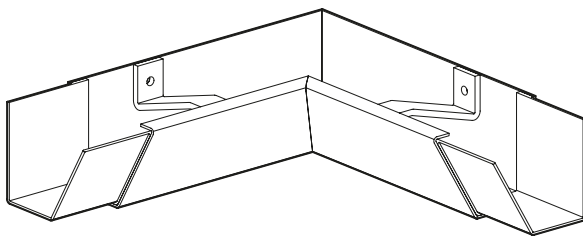

Internal Angle

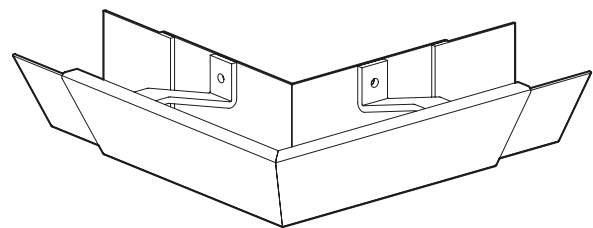

External Angle

PRICE LIST

RAKED BOX GUTTER SYSTEM

SLEEVE OUTLETS - ROUND

Gutter (mm)	100 x 75	100 x 100	125 x 100	150 x 100	150 x 150	200 x 150	200 x 200	300 x 200
63mm Ø	RBX1/SO13	RBX2/SO13	RBX3/SO13	RBX4/SO13	RBX5/SO13	RBX6/SO13	RBX7/SO13	RBX8/SO13
MILL	-	-	10.91	10.91	10.91	10.91	10.91	10.91
PPC	-	-	11.46	11.46	11.46	11.46	11.46	11.46
75mm Ø	RBX1/SO14	RBX2/SO14	RBX3/SO14	RBX4/SO14	RBX5/SO14	RBX6/SO14	RBX7/SO14	RBX8/SO14
MILL	-	-	-	10.91	10.91	10.91	10.91	10.91
PPC	-	-	-	11.46	11.46	11.46	11.46	11.46
100mm Ø	RBX1/SO15	RBX2/SO15	RBX3/SO15	RBX4/SO15	RBX5/SO15	RBX6/SO15	RBX7/SO15	RBX8/SO15
MILL	-	-	-	-	-	12.69	12.69	12.69
PPC	-	-	-	-	-	13.24	13.24	13.24
125mm Ø	RBX1/SO16	RBX2/SO16	RBX3/SO16	RBX4/SO16	RBX5/SO16	RBX6/SO16	RBX7/SO16	RBX8/SO16
MILL	-	-	-	-	-	-	-	12.69
PPC	-	-	-	-	-	-	-	13.24
150mm Ø	RBX1/SO17	RBX2/SO17	RBX3/SO17	RBX4/SO17	RBX5/SO17	RBX6/SO17	RBX7/SO17	RBX8/SO17
MILL	-	-	-	-	-	-	-	14.40
PPC	-	-	-	-	-	-	-	14.95

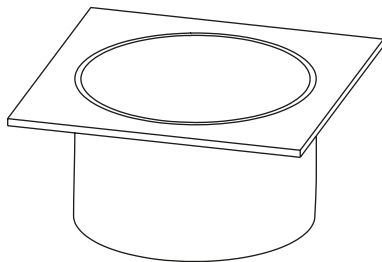

Please Note

Sleeve Outlets can be used in place of Running Outlets giving increased flexibility and cost efficiency.

PRICE LIST

RAKED BOX GUTTER SYSTEM

SLEEVE OUTLETS - SQUARE & RECTANGULAR

Gutter (mm)	100 x 75	100 x 100	125 x 100	150 x 100	150 x 150	200 x 150	200 x 200	300 x 200
75 x 50mm	RBX1/SO18	RBX2/SO18	RBX3/SO18	RBX4/SO18	RBX5/SO18	RBX6/SO18	RBX7/SO18	RBX8/SO18
MILL	-	-	10.91	10.91	10.91	10.91	10.91	10.91
PPC	-	-	11.46	11.46	11.46	11.46	11.46	11.46
75 x 75mm	RBX1/SO19	RBX2/SO19	RBX3/SO19	RBX4/SO19	RBX5/SO19	RBX6/SO19	RBX7/SO19	RBX8/SO19
MILL	-	-	-	10.91	10.91	10.91	10.91	10.91
PPC	-	-	-	11.46	11.46	11.46	11.46	11.46
100 x 75mm	RBX1/SO20	RBX2/SO20	RBX3/SO20	RBX4/SO20	RBX5/SO20	RBX6/SO20	RBX7/SO20	RBX8/SO20
MILL	-	-	-	10.91	10.91	10.91	10.91	10.91
PPC	-	-	-	11.46	11.46	11.46	11.46	11.46
100 x 100mm	RBX1/SO21	RBX2/SO21	RBX3/SO21	RBX4/SO21	RBX5/SO21	RBX6/SO21	RBX7/SO21	RBX8/SO21
MILL	-	-	-	-	-	12.69	12.69	12.69
PPC	-	-	-	-	-	13.24	13.24	13.24
100 x 100mm	RBX1/SO22	RBX2/SO22	RBX3/SO22	RBX4/SO22	RBX5/SO22	RBX6/SO22	RBX7/SO22	RBX8/SO22
MILL	-	-	-	-	-	-	-	14.40
PPC	-	-	-	-	-	-	-	14.95

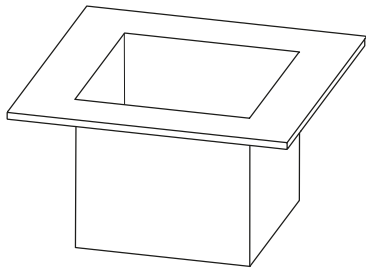

Please Note

Sleeve Outlets can be used in place of Running Outlets giving increased flexibility and cost efficiency.

PRICE LIST

RAKED BOX GUTTER SYSTEM

RUNNING OUTLETS - ROUND

Gutter (mm)	100 x 75	100 x 100	125 x 100	150 x 100	150 x 150	200 x 150	200 x 200	300 x 200
63mm Ø	RBX1/13	RBX2/13	RBX3/13	RBX4/13	RBX5/13	RBX6/13	RBX7/13	RBX8/13
MILL	49.46	50.43	51.86	54.25	60.24	71.84	79.66	93.60
PPC	50.54	51.71	53.26	55.75	62.14	73.95	82.18	96.57
75mm Ø	RBX1/14	RBX2/14	RBX3/14	RBX4/14	RBX5/14	RBX6/14	RBX7/14	RBX8/14
MILL	50.50	51.46	52.90	55.29	61.28	72.87	80.69	94.64
PPC	51.58	52.74	54.30	56.79	63.18	74.98	83.21	97.61
100mm Ø	RBX1/15	RBX2/15	RBX3/15	RBX4/15	RBX5/15	RBX6/15	RBX7/15	RBX8/15
MILL	-	-	55.87	58.25	64.25	75.84	83.66	97.60
PPC	-	-	57.27	59.75	66.15	77.95	86.18	100.57
125mm Ø	RBX1/16	RBX2/16	RBX3/16	RBX4/16	RBX5/16	RBX6/16	RBX7/16	RBX8/16
MILL	-	-	-	63.42	69.68	82.89	89.37	103.57
PPC	-	-	-	65.12	71.84	85.29	92.22	106.94
150mm Ø	RBX1/17	RBX2/17	RBX3/17	RBX4/17	RBX5/17	RBX6/17	RBX7/17	RBX8/17
MILL	-	-	-	-	-	85.22	91.70	105.88
PPC	-	-	-	-	-	87.62	94.55	109.25

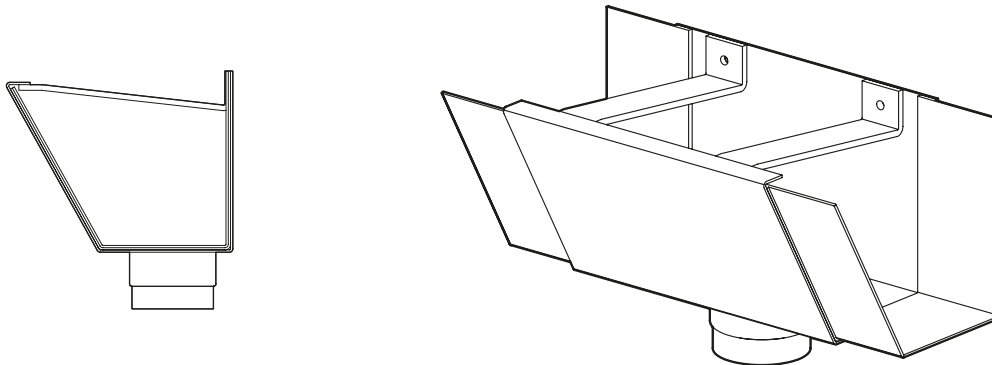

Please Note

Sleeve Outlets can be used in place of Running Outlets giving increased flexibility and cost efficiency.

PRICE LIST

RAKED BOX GUTTER SYSTEM

RUNNING OUTLETS - SQUARE & RECTANGULAR

Gutter (mm)	100 x 75	100 x 100	125 x 100	150 x 100	150 x 150	200 x 150	200 x 200	300 x 200
75 x 50mm	RBX1/18	RBX2/18	RBX3/18	RBX4/18	RBX5/18	RBX6/18	RBX7/18	RBX8/18
MILL	51.88	50.90	52.32	58.64	64.64	76.23	84.04	97.99
PPC	53.00	52.22	53.72	60.14	66.54	78.34	86.56	100.96
75 x 75mm	RBX1/19	RBX2/19	RBX3/19	RBX4/19	RBX5/19	RBX6/19	RBX7/19	RBX8/19
MILL	51.95	53.00	53.58	59.96	65.96	77.55	85.37	99.31
PPC	53.07	54.32	54.98	61.46	67.86	79.66	87.89	102.28
100 x 75mm	RBX1/20	RBX2/20	RBX3/20	RBX4/20	RBX5/20	RBX6/20	RBX7/20	RBX8/20
MILL	52.16	53.20	54.83	58.80	65.73	77.33	85.15	99.08
PPC	53.28	54.52	56.23	60.30	67.63	79.44	87.67	102.05
100 x 100mm	RBX1/21	RBX2/21	RBX3/21	RBX4/21	RBX5/21	RBX6/21	RBX7/21	RBX8/21
MILL	-	-	56.21	63.76	69.76	81.35	89.17	103.10
PPC	-	-	57.61	65.26	71.66	83.46	91.69	106.07
150 x 100mm	RBX1/22	RBX2/22	RBX3/22	RBX4/22	RBX5/22	RBX6/22	RBX7/22	RBX8/22
MILL	-	-	59.81	63.15	70.34	82.62	89.10	104.23
PPC	-	-	61.40	64.85	72.50	85.02	91.95	107.60
150 x 150mm	RBX1/23	RBX2/23	RBX3/23	RBX4/23	RBX5/23	RBX6/23	RBX7/23	RBX8/23
MILL	-	-	-	-	-	86.42	92.90	108.04
PPC	-	-	-	-	-	88.82	95.75	111.41

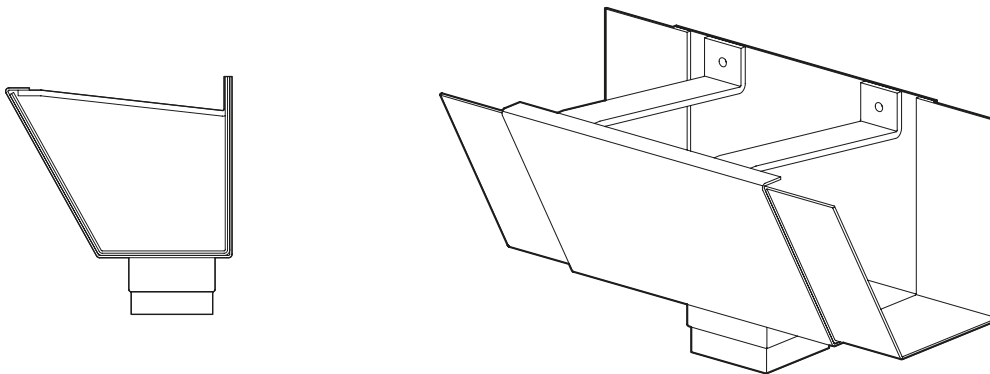

Please Note

Sleeve Outlets can be used in place of Running Outlets giving increased flexibility and cost efficiency.

PRICE LIST

FIXINGS & SEALANTS

Code	Qty	Description	Price
GM1	25	Gutter Fixing 38 x 5.5 A2 Stainless Steel	4.56
GM2	100	Gutter Fixing 38 x 5.5 A2 Stainless Steel	13.86
GM3	200	Gutter Fixing 38 x 5.5 A2 Stainless Steel	26.90



GM1 - GM5

Code	Qty	Description	Price
GM201	25	4.8 x 14.7 All Aluminium sealed Rivet	3.38
GM202	100	4.8 x 14.7 All Aluminium sealed Rivet	12.46
GM203	200	4.8 x 14.7 All Aluminium sealed Rivet	23.38



GM201 - GM203

Code	Qty	Description	Price
GM610	25	6.3mm STRUCTURAL Aluminium Rivet	10.97
GM620	100	6.3mm STRUCTURAL Aluminium Rivet	39.11
GM630	200	6.3mm STRUCTURAL Aluminium Rivet	78.21



GM610 - GM620

Code	Qty	Description	Price
GM20	25	Downpipe Fixing 6 x 50 A2 Stainless Steel	9.81
GM21	100	Downpipe Fixing 6 x 50 A2 Stainless Steel	32.84



GM20 - GM21

Code	Qty	Description	Price
GM30	1	380ml Cartridge Silicone Sealant - Grey	11.00
GM32	1	1no 12mtr Reel Butyl Tape 12mm x 3mm	6.56
GM40	1	Touch Up Paint - Colour to match order	23.98
GM50	1	1no Drill Bit 4.8mm	2.06
GM51	1	1no Drill Bit 6.4mm	2.74



GM30



GM32



GM50 - GM60

Code	Qty	Description	Price
GM910	1	Standard Rainwater Rivet Gun	20.13
GM920	1	Professional Rivet Gun - Interchangeable collets for rain-water and structural rivets	115.19



GM910



GM920

PRICE LIST

CARRIAGE CHARGES

GUTTERS, DOWNPIPES & HOPPERS

TOTAL NET ORDER VALUE (EXCLUDING VAT)		PRICE
£0 - £99	BOXED UP TO 10KG	£15 Min Charge
£0 - £99	3M LENGTHS UP TO 10KGS	£30
£100 - £624		£40
£625 - £1249		£55
£1250 PLUS		FREE DELIVERY

Delivery Exclusions Apply:
Please see the Charges
section below

COPING, FASCIAS & SOFFITS

TOTAL NET ORDER VALUE (EXCLUDING VAT)	PRICE
£0 - £150	£40
£151 - £1249	£95
£1250 PLUS	FREE DELIVERY

Delivery Exclusions Apply:
Please see the Charges
section below

CHARGES

With a fleet of Guttercrest vehicles and outside couriers, we deliver all our aluminium products to your local builders merchant or direct to site.

SCOTTISH MAINLAND

Standard carriage charges apply on
Postcode areas: DG, EH, G, KA, KY, TD

ALSO TO INCLUDE: DD1 - DD7, FK1 - FK7, FK9 - FK15,
FK8 STERLING ONLY (Rest of FK8 will be price on application),
KY1 - KY16, PA1 - PA19, PH1 - PH4, PH12 - PH14

All other Scottish Mainland, carriage price on application.

NON MAINLAND

For delivery to Northern Ireland, The Republic of Ireland
and all offshore Islands, carriage Price on application.

EXPORT

Price on application.

Tel: +44 (0)1691 663300

Email: info@guttercrest.co.uk

VAT will be charged at the appropriate rate.

